

# *Power LED I*

## *TECHNICAL DATA*

*W10190*

*N10190*

*D10190*

*B10190*

*G10190*

*R10190*

*C10190*

*A10190*



**SEOUL SEMICONDUCTOR CO., LTD.**

148-29, Kasan-Dong, Keumchun-Gu, Seoul, Korea

TEL : 82-2-3281-6269 FAX : 82-2-857-5430

Rev09 – 2005/09

# ***SPECIFICATIONS***

---

## **- Features**

- Super high flux output and high luminance
- Designed for high current operation
- Low thermal resistance
- SMT solderability
- Lead (Pb) Free Product – RoHS Compliant

## **- Applications**

- General Illumination
  - Outdoor & Indoor architectural lighting
  - Decorative lighting
  - Torch lighting
  - Portable lighting (Flash and lamp) and Reading lighting
  - Traffic signaling

## **- Description**

Z-Power series is designed for high current operation and high flux output applications.

Z-Power LED's thermal management perform exceeds other power LED solutions.

It incorporates state of the art SMD design and Thermal emission material.

Z Power LED is ideal light sources for general illumination applications, custom designed solutions, automotive large LCD backlights.



**SEOUL SEMICONDUCTOR CO., LTD.**

148-29, Kasan-Dong, Keumchun-Gu, Seoul, Korea

TEL : 82-2-3281-6269 FAX : 82-2-857-5430

Rev09 – 2005/09

## Full Code explanation of Z-Power LED series

Full code form :  $X_1 X_2 X_3 X_4 X_5 X_6 - X_7 X_8 - X_9 X_{10} X_{11} X_{12} X_{13}$

### 1. Part number

- $X_1$  : Color
- $X_2$  : Z-Power LED series number
- $X_3$  : LENS type
- $X_4$  : Chip Quantity
- $X_5$  : Package outline size
- $X_6$  : Type of PCB

### 2. Internal Number

- $X_7$
- $X_8$

### 3. Code Labeling

- $X_9$  : Luminous Flux (or Radiant Flux for Royal)
- $X_{10} X_{11} X_{12}$  : Dominant Wavelength (or x,y coordinates rank code)
- $X_{13}$  : Forward Voltage

**For more information about binning and labeling, refer to the Application Note -1**



**SEOUL SEMICONDUCTOR CO., LTD.**  
148-29, Kasan-Dong, Keumchun-Gu, Seoul, Korea  
TEL : 82-2-3281-6269 FAX : 82-2-857-5430  
Rev09 – 2005/09

## 1. Outline Dimensions

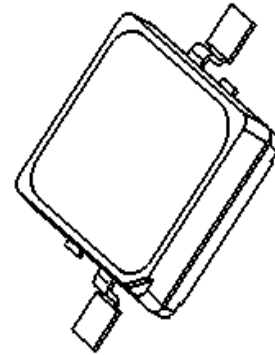
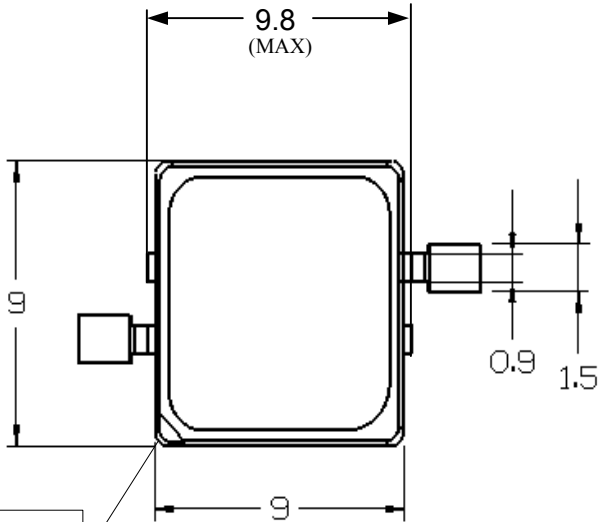

Isometric view  
Scale: None

Cathode  
Mark

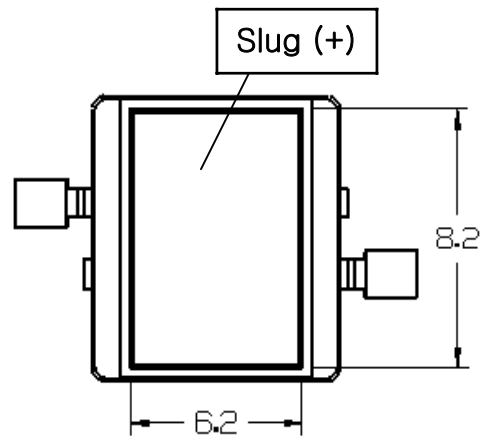
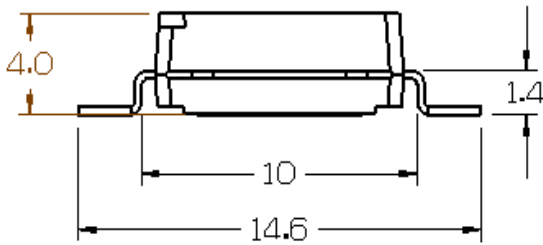

Rear view

- Notes :
1. All dimensions are in millimeters.
  2. Scale : none
  3. This drawing is reference only for engineering
  4. Slug of package is connected to anode.



**SEOUL SEMICONDUCTOR CO., LTD.**  
148-29, Kasan-Dong, Keumchun-Gu, Seoul, Korea  
TEL : 82-2-3281-6269 FAX : 82-2-857-5430  
Rev09 – 2005/09

# Pure white Power LED

## 2. Electro-Optical Characteristics (at $I_F=350\text{mA}$ , $T_A=25^\circ\text{C}$ )

Parameter	Symbol	Value			Unit
		Min	Typ	Max	
Luminous Flux <sup>[1]</sup>	$\Phi_V$ <sup>[2]</sup>	32	52	-	lm
Correlated Color Temperature <sup>[3]</sup>	CCT	-	6500	-	K
CRI	$R_a$	-	70	-	-
Forward Voltage <sup>[4]</sup>	$V_F$	3.0	3.5	4.0	V
View Angle	$2\Theta$ 1/2	110			deg.
Thermal resistance <sup>[5]</sup>	$R_{\Theta_{J-B}}$	8			$^\circ\text{C}/\text{W}$

## 3. Absolute Maximum Ratings (at $T_A=25^\circ\text{C}$ )

Parameter	Symbol	Value	Unit
Forward Current	$I_F$	0.4	A
Power Dissipation	$P_D$	1.6	W
Junction Temperature	$T_j$	125	$^\circ\text{C}$
Operating Temperature	$T_{opr}$	-30 ~ +85	$^\circ\text{C}$
Storage Temperature	$T_{stg}$	-40 ~ +120	$^\circ\text{C}$
ESD Sensitivity <sup>[6]</sup>	-	$\pm 20,000\text{V}$ HBM	-

\*Notes :

- [1] SSC maintains a tolerance of  $\pm 10\%$  on flux and power measurements.
- [2]  $\Phi_V$  is the total luminous flux output as measured with an integrated sphere.
- [3] Correlated Color Temperature is derived from the CIE 1931 Chromaticity diagram.  
CCT  $\pm 5\%$  tester tolerance
- [4] A tolerance of  $\pm 0.06\text{V}$  on forward voltage measurements
- [5]  $R_{\Theta_{J-B}}$  is measured with a SSC metal core pcb. ( $25^\circ\text{C} \leq T_j \leq 110^\circ\text{C}$ )  
Break voltage of Metal PCB is 6.5kVAC
- [6] It is included the zener chip to protect the product from ESD.

-----Caution-----

1. Please do not drive at rated current more than 5 sec. without proper heat sink
2. The chromaticity coordinate of the LEDs can shift approximately  $x=0.02$ ,  $y=0.03$  in the direction of blue 1000 hours later



**SEOUL SEMICONDUCTOR CO., LTD.**  
 148-29, Kasan-Dong, Keumchun-Gu, Seoul, Korea  
 TEL : 82-2-3281-6269 FAX : 82-2-857-5430  
 Rev09 – 2005/09

# Warm white Power LED

## 2. Electro-Optical Characteristics (at $I_F=350\text{mA}$ , $T_A=25^\circ\text{C}$ )

Parameter	Symbol	Value			Unit
		Min	Typ	Max	
Luminous Flux <sup>[1]</sup>	$\Phi_V$ <sup>[2]</sup>	24.5	35	-	lm
Correlated Color Temperature <sup>[3]</sup>	CCT	-	3000	-	K
CRI	$R_a$	-	80	-	-
Forward Voltage <sup>[4]</sup>	$V_F$	3.0	3.5	4.0	V
View Angle	$2\Theta$ 1/2	110			deg.
Thermal resistance <sup>[5]</sup>	$R_{\Theta J-B}$	8			$^\circ\text{C}/\text{W}$

## 3. Absolute Maximum Ratings (at $T_A=25^\circ\text{C}$ )

Parameter	Symbol	Value	Unit
Forward Current	$I_F$	0.4	A
Power Dissipation	$P_D$	1.6	W
Junction Temperature	$T_j$	125	$^\circ\text{C}$
Operating Temperature	$T_{opr}$	-30 ~ +85	$^\circ\text{C}$
Storage Temperature	$T_{stg}$	-40 ~ +120	$^\circ\text{C}$
ESD Sensitivity <sup>[6]</sup>	-	$\pm 20,000\text{V}$ HBM	-

\*Notes :

[1] SSC maintains a tolerance of  $\pm 10\%$  on flux and power measurements.

[2]  $\Phi_V$  is the total luminous flux output as measured with an integrated sphere.

[3] Correlated Color Temperature is derived from the CIE 1931 Chromaticity diagram.

CCT  $\pm 5\%$  tester tolerance

[4] A tolerance of  $\pm 0.06\text{V}$  on forward voltage measurements

[5]  $R_{\Theta J-B}$  is measured with a SSC metal core pcb. ( $25^\circ\text{C} \leq T_j \leq 110^\circ\text{C}$ )

Break voltage of Metal PCB is 6.5kVAC

[6] It is included the zener chip to protect the product from ESD.

-----Caution-----

1. Please do not drive at rated current more than 5 sec. without proper heat sink
2. The chromaticity coordinate of the LEDs can shift approximately  $x=0.02$ ,  $y=0.03$  in the direction of blue 1000 hours later



**SEOUL SEMICONDUCTOR CO., LTD.**

148-29, Kasan-Dong, Keumchun-Gu, Seoul, Korea

TEL : 82-2-3281-6269 FAX : 82-2-857-5430

Rev09 – 2005/09

# Royal Blue Power LED

## 2. Electro-Optical Characteristics (at $I_F=350\text{mA}$ , $T_A=25^\circ\text{C}$ )

Parameter	Symbol	Value			Unit
		Min	Typ	Max	
Radiant Flux <sup>[1]</sup>	$\Phi_V$ <sup>[2]</sup>	80	255	-	mW
Dominant Wavelength <sup>[3]</sup>	$\lambda_D$	455	460	465	nm
Forward Voltage <sup>[4]</sup>	$V_F$	3.0	3.5	4.0	V
View Angle	$2\Theta$ 1/2	130			deg.
Thermal Resistance <sup>[5]</sup>	$R\Theta_{J-B}$	8			$^\circ\text{C}/\text{W}$

## 3. Absolute Maximum Ratings (at $T_A=25^\circ\text{C}$ )

Parameter	Symbol	Value	Unit
Forward Current	$I_F$	0.4	A
Power Dissipation	$P_D$	1.6	W
Junction Temperature	$T_j$	125	$^\circ\text{C}$
Operating Temperature	$T_{opr}$	-30 ~ +85	$^\circ\text{C}$
Storage Temperature	$T_{stg}$	-40 ~ +120	$^\circ\text{C}$
ESD Sensitivity <sup>[6]</sup>	-	$\pm 20,000\text{V}$ HBM	-

\*Notes :

[1] SSC maintains a tolerance of  $\pm 10\%$  on flux and power measurements. Royal Blue product is binned by radiometric power rather than photometric lumens.

[2]  $\Phi_V$  is the total luminous flux output as measured with an integrated sphere.

[3] Dominant wavelength is derived from the CIE 1931 Chromaticity diagram.

A tolerance of  $\pm 0.5\text{nm}$  for dominant wavelength

[4] A tolerance of  $\pm 0.06\text{V}$  on forward voltage measurements

[5]  $R\Theta_{J-B}$  is measured with a SSC metal core pcb. ( $25^\circ\text{C} \leq T_j \leq 110^\circ\text{C}$ )

Break voltage of Metal PCB is 6.5kVAC

[6] It is included the zener chip to protect the product from ESD.

-----Caution-----

1. Please do not drive at rated current more than 5 sec. without proper heat sink
2. Blue power light sources represented here are IEC825 Class 2 for eye safety



**SEOUL SEMICONDUCTOR CO., LTD.**

148-29, Kasan-Dong, Keumchun-Gu, Seoul, Korea

TEL : 82-2-3281-6269 FAX : 82-2-857-5430

Rev09 – 2005/09

# Blue Power LED

## 2. Electro-Optical Characteristics (at $I_F=350\text{mA}$ , $T_A=25^\circ\text{C}$ )

Parameter	Symbol	Value			Unit
		Min	Typ	Max	
Luminous Flux <sup>[1]</sup>	$\Phi_V$ <sup>[2]</sup>	6	11	-	lm
Dominant Wavelength <sup>[3]</sup>	$\lambda_D$	455	460	475	nm
Forward Voltage <sup>[4]</sup>	$V_F$	3.0	3.5	4.0	V
View Angle	$2\Theta$ 1/2	130			deg.
Thermal Resistance <sup>[5]</sup>	$R\Theta_{J-B}$	8			$^\circ\text{C}/\text{W}$

## 3. Absolute Maximum Ratings (at $T_A=25^\circ\text{C}$ )

Parameter	Symbol	Value	Unit
Forward Current	$I_F$	0.4	A
Power Dissipation	$P_D$	1.6	W
Junction Temperature	$T_j$	125	$^\circ\text{C}$
Operating Temperature	$T_{opr}$	-30 ~ +85	$^\circ\text{C}$
Storage Temperature	$T_{stg}$	-40 ~ +120	$^\circ\text{C}$
ESD Sensitivity <sup>[6]</sup>	-	$\pm 20,000\text{V}$ HBM	-

\*Notes :

[1] SSC maintains a tolerance of  $\pm 10\%$  on flux and power measurements.

[2]  $\Phi_V$  is the total luminous flux output as measured with an integrated sphere.

[3] Dominant wavelength is derived from the CIE 1931 Chromaticity diagram.

A tolerance of  $\pm 0.5\text{nm}$  for dominant wavelength

[4] A tolerance of  $\pm 0.06\text{V}$  on forward voltage measurements

[5]  $R\Theta_{J-B}$  is measured with a SSC metal core pcb. ( $25^\circ\text{C} \leq T_j \leq 110^\circ\text{C}$ )

Break voltage of Metal PCB is 6.5kVAC

[6] It is included the zener chip to protect the product from ESD.

### -----Caution-----

1. Please do not drive at rated current more than 5 sec. without proper heat sink
2. Blue power light sources represented here are IEC825 Class 2 for eye safety



**SEOUL SEMICONDUCTOR CO., LTD.**

148-29, Kasan-Dong, Keumchun-Gu, Seoul, Korea

TEL : 82-2-3281-6269 FAX : 82-2-857-5430

Rev09 – 2005/09



# Green Power LED

## 2. Electro-Optical Characteristics (at $I_F=350\text{mA}$ , $T_A=25^\circ\text{C}$ )

Parameter	Symbol	Value			Unit
		Min	Typ	Max	
Luminous Flux <sup>[1]</sup>	$\Phi_V$ <sup>[2]</sup>	24.5	48	-	lm
Dominant Wavelength <sup>[3]</sup>	$\lambda_D$	520	527	535	nm
Forward Voltage <sup>[4]</sup>	$V_F$	3.0	3.5	4.0	V
View Angle	$2\Theta$ 1/2	130			deg.
Thermal Resistance <sup>[5]</sup>	$R\Theta_{J-B}$	8			$^\circ\text{C}/\text{W}$

## 3. Absolute Maximum Ratings (at $T_A=25^\circ\text{C}$ )

Parameter	Symbol	Value	Unit
Forward Current	$I_F$	0.4	A
Power Dissipation	$P_D$	1.6	W
Junction Temperature	$T_j$	125	$^\circ\text{C}$
Operating Temperature	$T_{opr}$	-30 ~ +85	$^\circ\text{C}$
Storage Temperature	$T_{stg}$	-40 ~ +120	$^\circ\text{C}$
ESD Sensitivity <sup>[6]</sup>	-	$\pm 20,000\text{V}$ HBM	-

\*Notes :

[1] SSC maintains a tolerance of  $\pm 10\%$  on flux and power measurements.

[2]  $\Phi_V$  is the total luminous flux output as measured with an integrated sphere.

[3] Dominant wavelength is derived from the CIE 1931 Chromaticity diagram.

A tolerance of  $\pm 0.5\text{nm}$  for dominant wavelength

[4] A tolerance of  $\pm 0.06\text{V}$  on forward voltage measurements

[5]  $R\Theta_{J-B}$  is measured with a SSC metal core pcb. ( $25^\circ\text{C} \leq T_j \leq 110^\circ\text{C}$ )

Break voltage of Metal PCB is 6.5kVAC

[6] It is included the zener chip to protect the product from ESD.

### -----Caution-----

**Please do not drive at rated current more than 5 sec. without proper heat sink**



**SEOUL SEMICONDUCTOR CO., LTD.**

148-29, Kasan-Dong, Keumchun-Gu, Seoul, Korea

TEL : 82-2-3281-6269 FAX : 82-2-857-5430

Rev09 – 2005/09

# Red Power LED

## 2. Electro-Optical Characteristics (at $I_F=350\text{mA}$ , $T_A=25^\circ\text{C}$ )

Parameter	Symbol	Value			Unit
		Min	Typ	Max	
Luminous Flux <sup>[1]</sup>	$\Phi_V$ <sup>[2]</sup>	24.5	30	-	lm
Dominant Wavelength <sup>[3]</sup>	$\lambda_D$	620	625	630	nm
Forward Voltage <sup>[4]</sup>	$V_F$	2.0	2.5	3.0	V
View Angle	$2\Theta$ 1/2	128			deg.
Thermal Resistance <sup>[5]</sup>	$R\Theta_{J-B}$	12			$^\circ\text{C}/\text{W}$

## 3. Absolute Maximum Ratings (at $T_A=25^\circ\text{C}$ )

Parameter	Symbol	Value	Unit
Forward Current	$I_F$	0.4	A
Power Dissipation	$P_D$	1.2	W
Junction Temperature	$T_j$	100	$^\circ\text{C}$
Operating Temperature	$T_{opr}$	-30 ~ +85	$^\circ\text{C}$
Storage Temperature	$T_{stg}$	-40 ~ +120	$^\circ\text{C}$
ESD Sensitivity <sup>[6]</sup>	-	$\pm 20,000\text{V}$ HBM	-

\*Notes :

[1] SSC maintains a tolerance of  $\pm 10\%$  on flux and power measurements.

[2]  $\Phi_V$  is the total luminous flux output as measured with an integrated sphere.

[3] Dominant wavelength is derived from the CIE 1931 Chromaticity diagram.

A tolerance of  $\pm 0.5\text{nm}$  for dominant wavelength

[4] A tolerance of  $\pm 0.06\text{V}$  on forward voltage measurements

[5]  $R\Theta_{J-B}$  is measured with a SSC metal core pcb. ( $25^\circ\text{C} \leq T_j \leq 110^\circ\text{C}$ )

Break voltage of Metal PCB is 6.5kVAC

[6] It is included the zener chip to protect the product from ESD.

### -----Caution-----

**Please do not drive at rated current more than 5 sec. without proper heat sink**



**SEOUL SEMICONDUCTOR CO., LTD.**

148-29, Kasan-Dong, Keumchun-Gu, Seoul, Korea

TEL : 82-2-3281-6269 FAX : 82-2-857-5430

Rev09 – 2005/09

# Cyan Power LED

## 2. Electro-Optical Characteristics (at $I_F=350\text{mA}$ , $T_A=25^\circ\text{C}$ )

Parameter	Symbol	Value			Unit
		Min	Typ	Max	
Luminous Flux [1]	$\Phi_V$ [2]	24.5	40	-	lm
Dominant Wavelength [3]	$\lambda_D$	500	505	510	nm
Forward Voltage [4]	$V_F$	3.0	3.5	4.0	V
View Angle	$2\Theta$ 1/2	130			deg.
Thermal Resistance [5]	$R\Theta_{J-B}$	8			$^\circ\text{C}/\text{W}$

## 3. Absolute Maximum Ratings (at $T_A=25^\circ\text{C}$ )

Parameter	Symbol	Value	Unit
Forward Current	$I_F$	0.4	A
Power Dissipation	$P_D$	1.6	W
Junction Temperature	$T_j$	125	$^\circ\text{C}$
Operating Temperature	$T_{opr}$	-30 ~ +85	$^\circ\text{C}$
Storage Temperature	$T_{stg}$	-40 ~ +120	$^\circ\text{C}$
ESD Sensitivity [6]	-	$\pm 20,000\text{V}$ HBM	-

\*Notes :

[1] SSC maintains a tolerance of  $\pm 10\%$  on flux and power measurements.

[2]  $\Phi_V$  is the total luminous flux output as measured with an integrated sphere.

[3] Dominant wavelength is derived from the CIE 1931 Chromaticity diagram.

A tolerance of  $\pm 0.5\text{nm}$  for dominant wavelength

[4] A tolerance of  $\pm 0.06\text{V}$  on forward voltage measurements

[5]  $R\Theta_{J-B}$  is measured with a SSC metal core pcb. ( $25^\circ\text{C} \leq T_j \leq 110^\circ\text{C}$ )

Break voltage of Metal PCB is 6.5kVAC

[6] It is included the zener chip to protect the product from ESD.

### -----Caution-----

**Please do not drive at rated current more than 5 sec. without proper heat sink**



**SEOUL SEMICONDUCTOR CO., LTD.**

148-29, Kasan-Dong, Keumchun-Gu, Seoul, Korea

TEL : 82-2-3281-6269 FAX : 82-2-857-5430

Rev09 – 2005/09

# Amber Power LED

## 2. Electro-Optical Characteristics (at $I_F=350\text{mA}$ , $T_A=25^\circ\text{C}$ )

Parameter	Symbol	Value			Unit
		Min	Typ	Max	
Luminous Flux <sup>[1]</sup>	$\Phi_V$ <sup>[2]</sup>	24.5	38	-	lm
Dominant Wavelength <sup>[3]</sup>	$\lambda_D$	585	590	595	nm
Forward Voltage <sup>[4]</sup>	$V_F$	2.0	2.5	3.0	V
View Angle	$2\Theta$ 1/2	128			deg.
Thermal Resistance <sup>[5]</sup>	$R\Theta_{J-B}$	12			$^\circ\text{C}/\text{W}$

## 3. Absolute Maximum Ratings (at $T_A=25^\circ\text{C}$ )

Parameter	Symbol	Value	Unit
Forward Current	$I_F$	0.4	A
Power Dissipation	$P_D$	1.2	W
Junction Temperature	$T_j$	100	$^\circ\text{C}$
Operating Temperature	$T_{opr}$	-30 ~ +85	$^\circ\text{C}$
Storage Temperature	$T_{stg}$	-40 ~ +120	$^\circ\text{C}$
ESD Sensitivity <sup>[6]</sup>	-	$\pm 20,000\text{V}$ HBM	-

\*Notes :

[1] SSC maintains a tolerance of  $\pm 10\%$  on flux and power measurements.

[2]  $\Phi_V$  is the total luminous flux output as measured with an integrated sphere.

[3] Dominant wavelength is derived from the CIE 1931 Chromaticity diagram.

A tolerance of  $\pm 0.5\text{nm}$  for dominant wavelength

[4] A tolerance of  $\pm 0.06\text{V}$  on forward voltage measurements

[5]  $R\Theta_{J-B}$  is measured with a SSC metal core pcb. ( $25^\circ\text{C} \leq T_j \leq 110^\circ\text{C}$ )

Break voltage of Metal PCB is 6.5kVAC

[6] It is included the zener chip to protect the product from ESD.

### -----Caution-----

**Please do not drive at rated current more than 5 sec. without proper heat sink**



**SEOUL SEMICONDUCTOR CO., LTD.**

148-29, Kasan-Dong, Keumchun-Gu, Seoul, Korea

TEL : 82-2-3281-6269 FAX : 82-2-857-5430

Rev09 – 2005/09

#### 4. Forward Voltage vs. Forward Current (Ta=25°C)

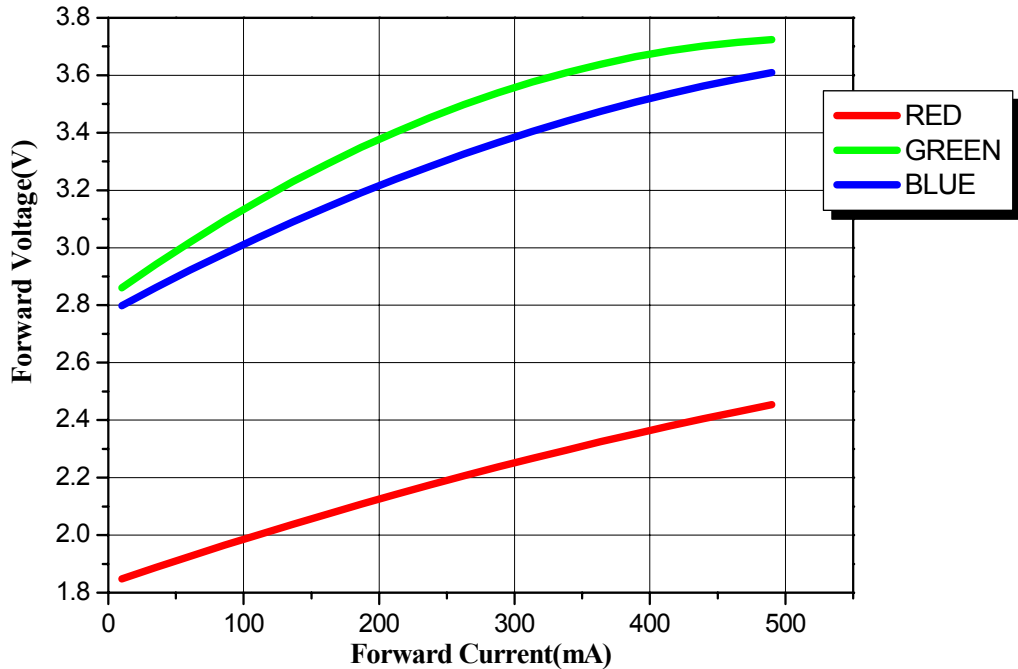

#### 5. Forward Current vs. Normalized Relative Luminous Flux (Ta=25°C)

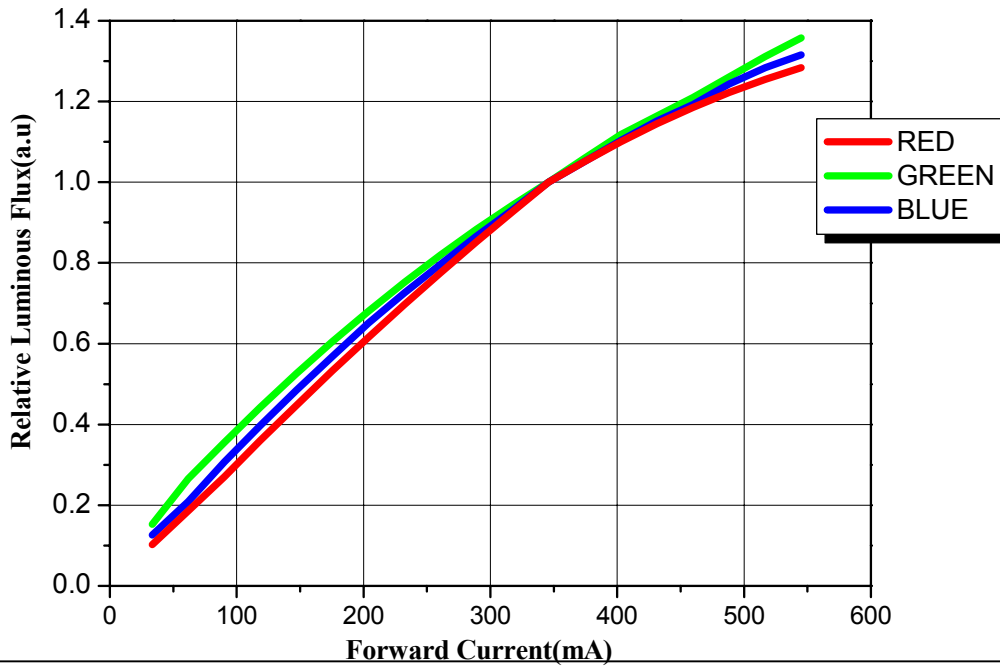

**SEOUL SEMICONDUCTOR CO., LTD.**

148-29, Kasan-Dong, Keumchun-Gu, Seoul, Korea

TEL : 82-2-3281-6269 FAX : 82-2-857-5430

Rev09 - 2005/09

## 6. White Color spectrum of Typical CCT (Ta=25°C)

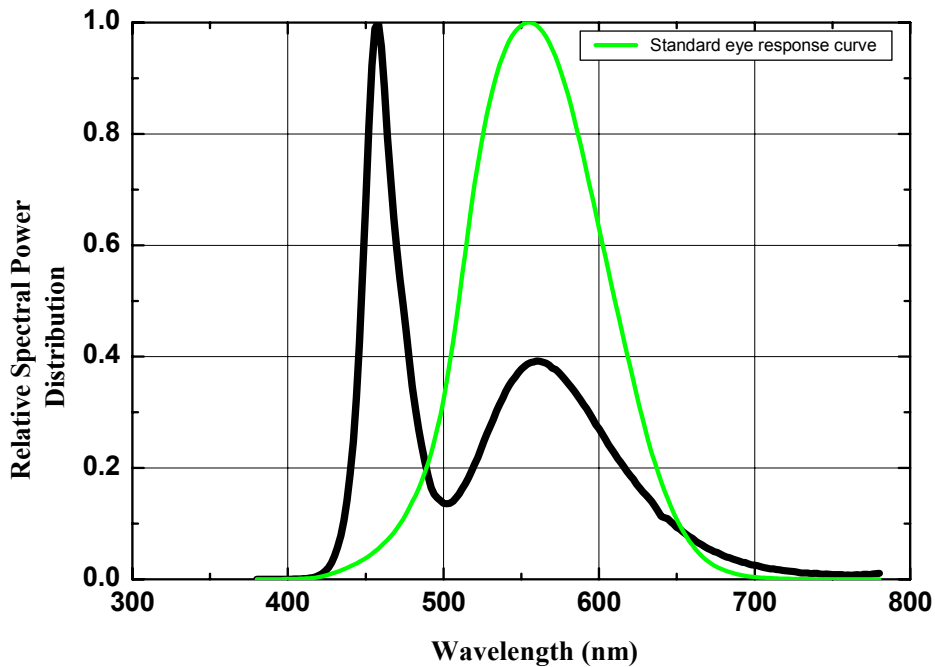

## 7. Warm White spectrum of Typical CCT (Ta=25°C)

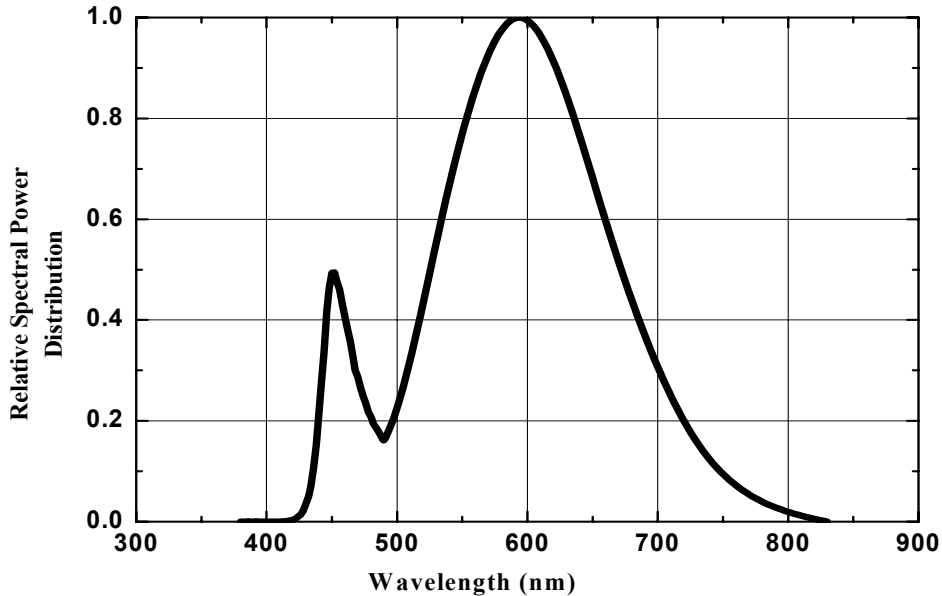

## 8. Spectrum for Red, Green, Blue, Amber, Cyan (Ta=25°C)

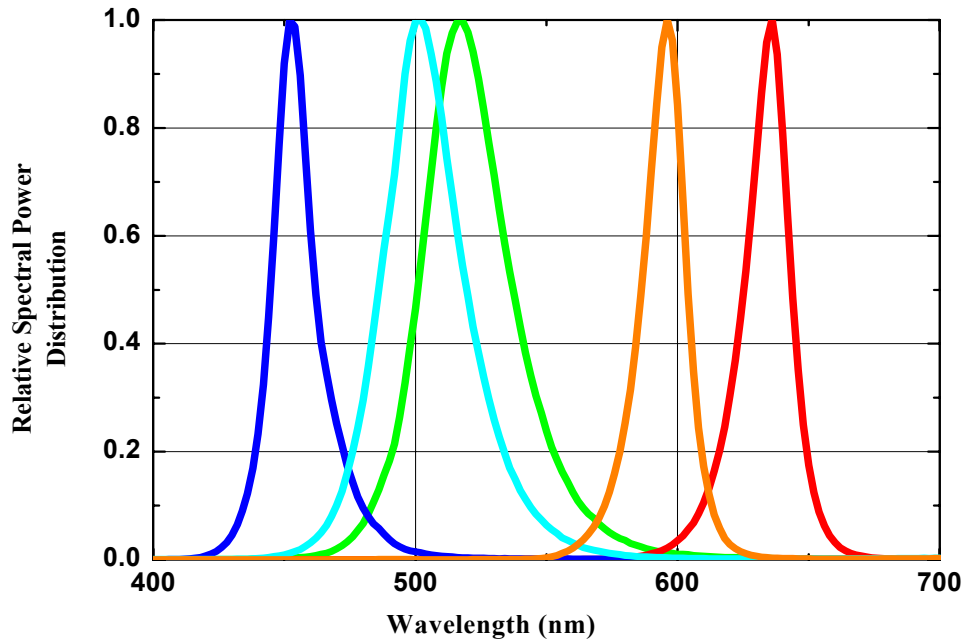

**SEOUL SEMICONDUCTOR CO., LTD.**  
148-29, Kasan-Dong, Keumchun-Gu, Seoul, Korea  
TEL : 82-2-3281-6269 FAX : 82-2-857-5430  
Rev09 – 2005/09

**9. Radiation pattern for White**

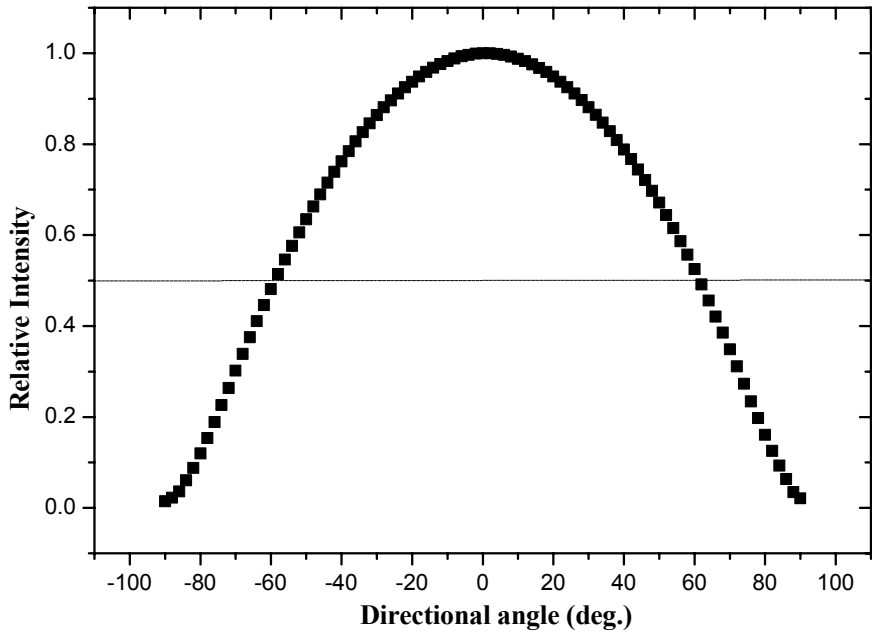

**10. Radiation pattern for Red**

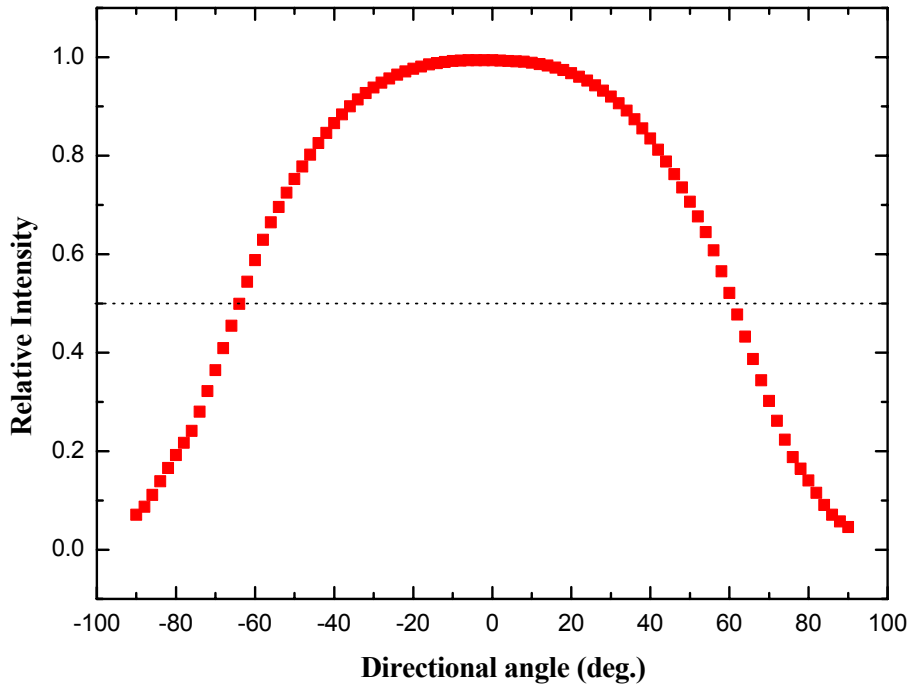



## 11. Radiation pattern for Green

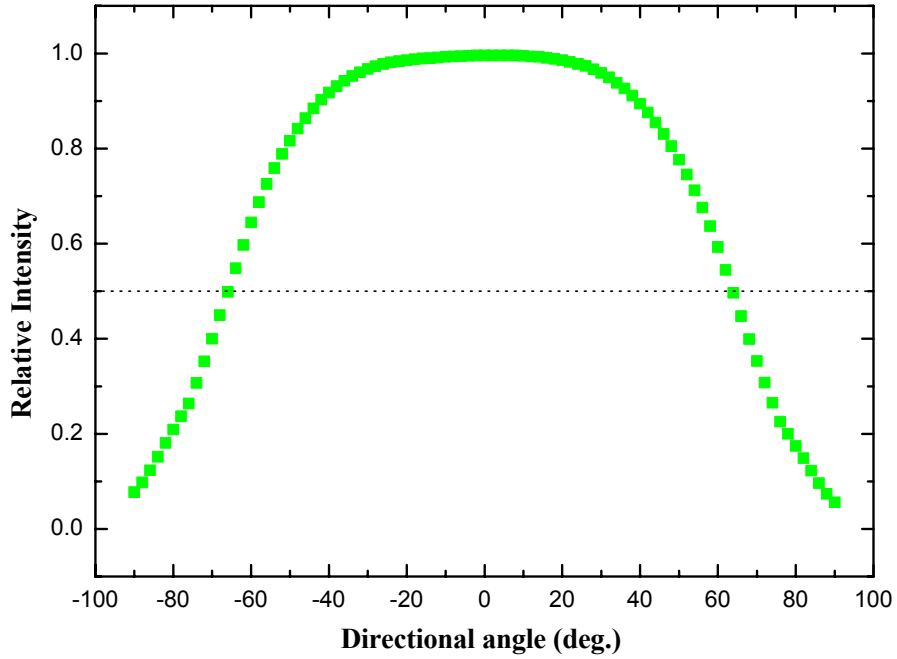

## 12. Radiation pattern for Blue

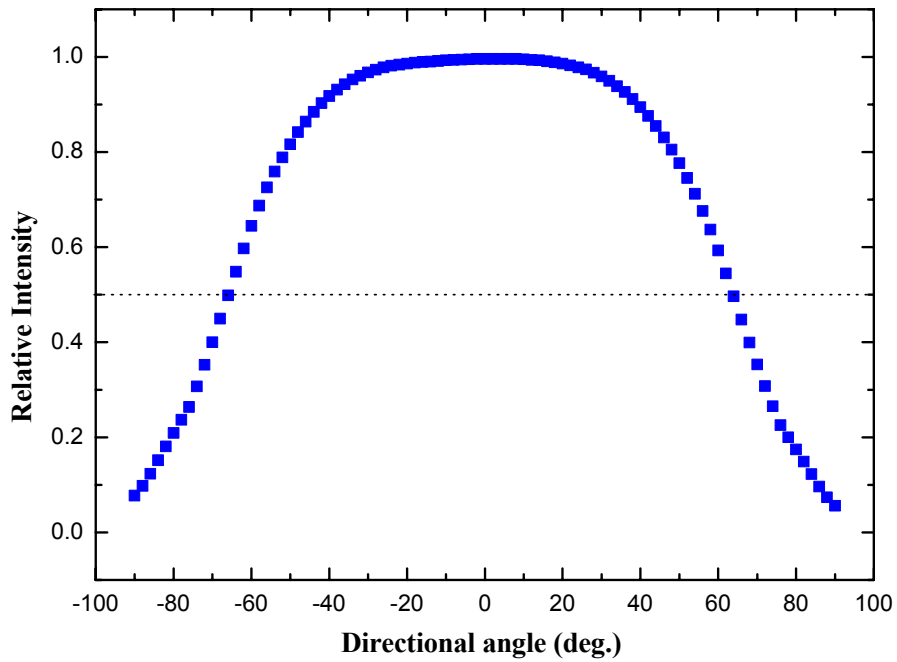

### 13. Radiation pattern for Cyan

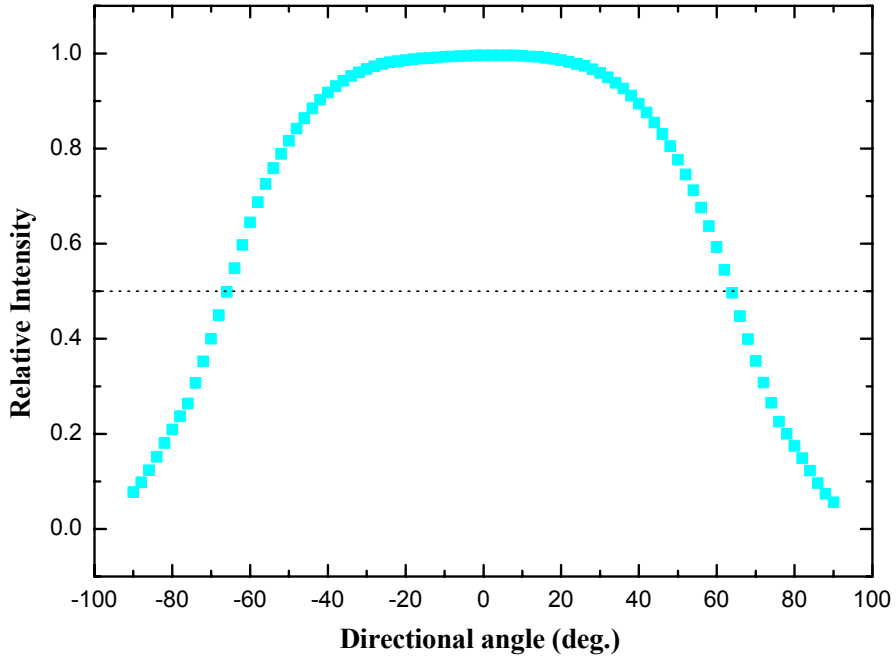

### 14. Radiation pattern for Amber

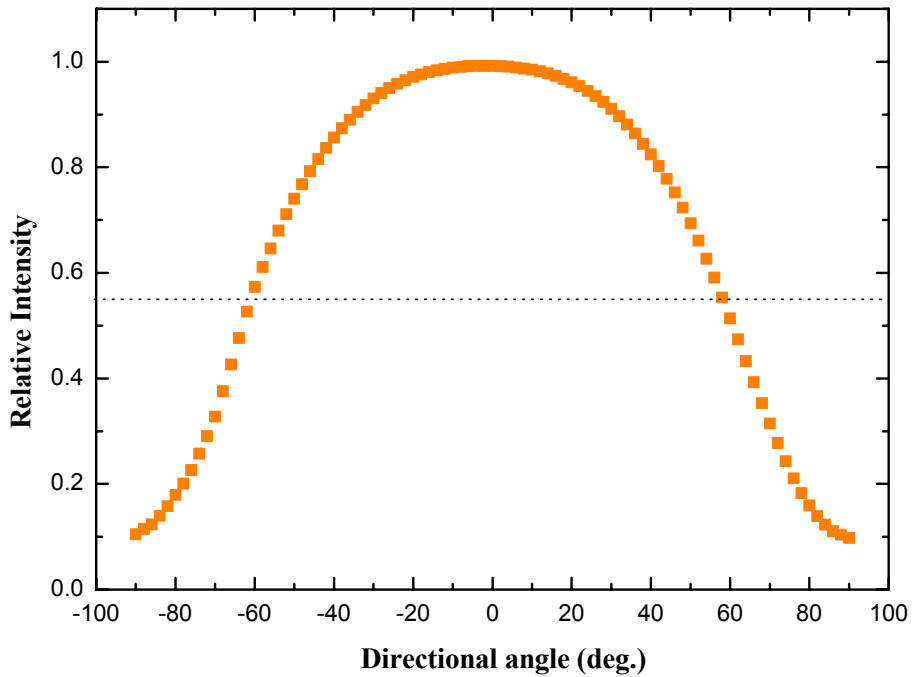

### 15. Forward Current Vs Wavelength shift (Ta=25°C)

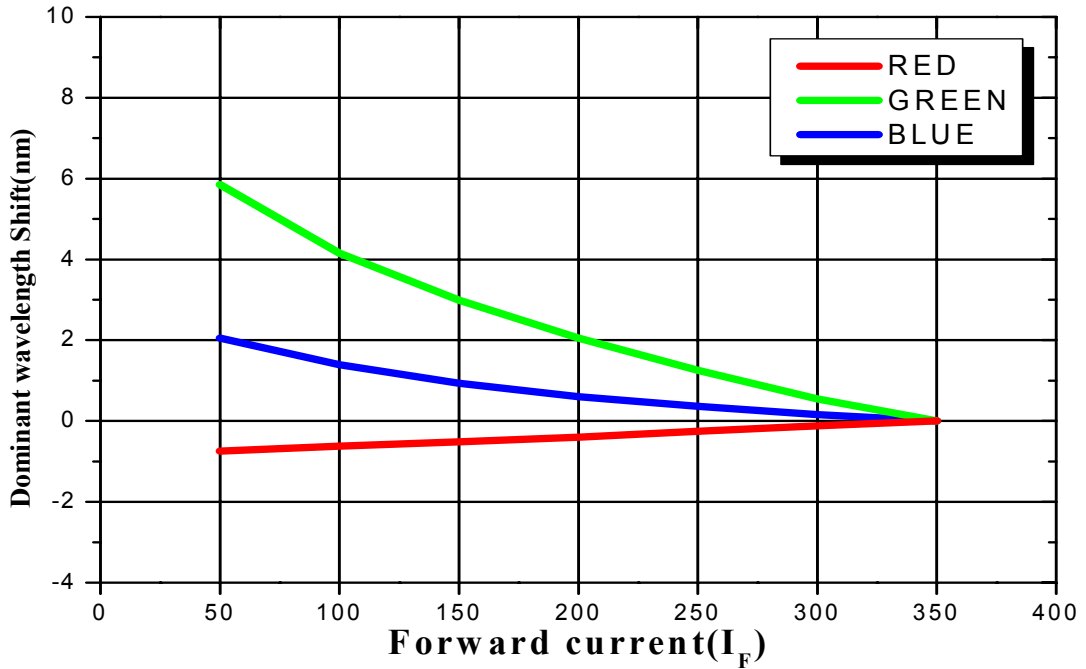

### 16. Junction Temp Vs Wavelength shift

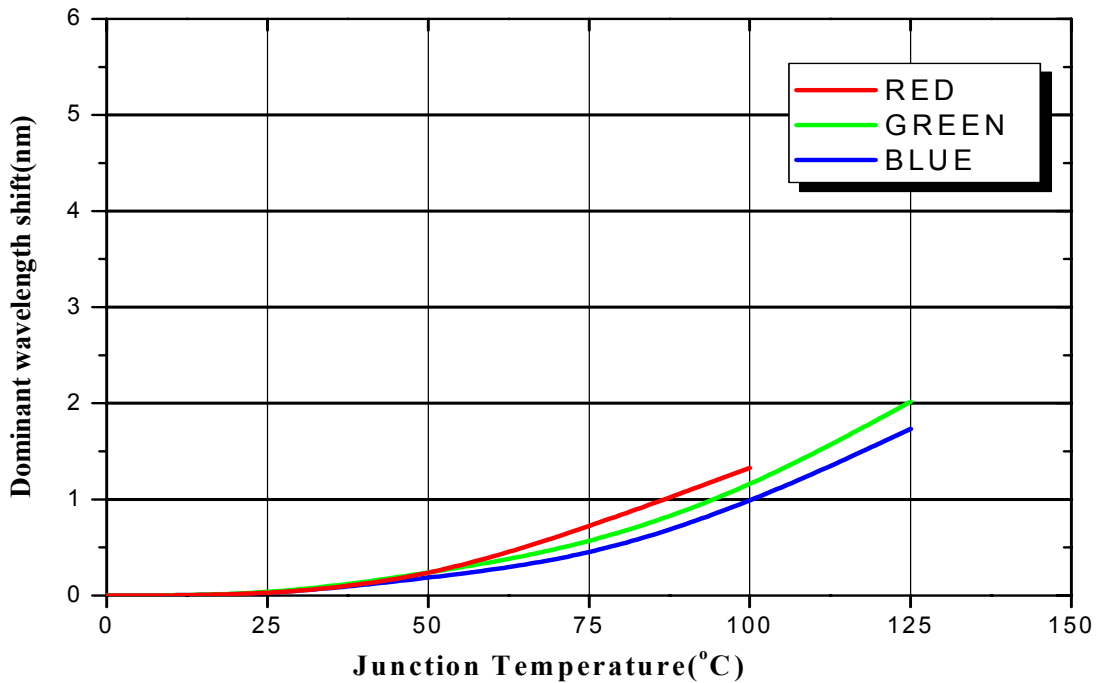

**17. Temperature of Junction vs. Relative Light Output for Blue,Green, Red**

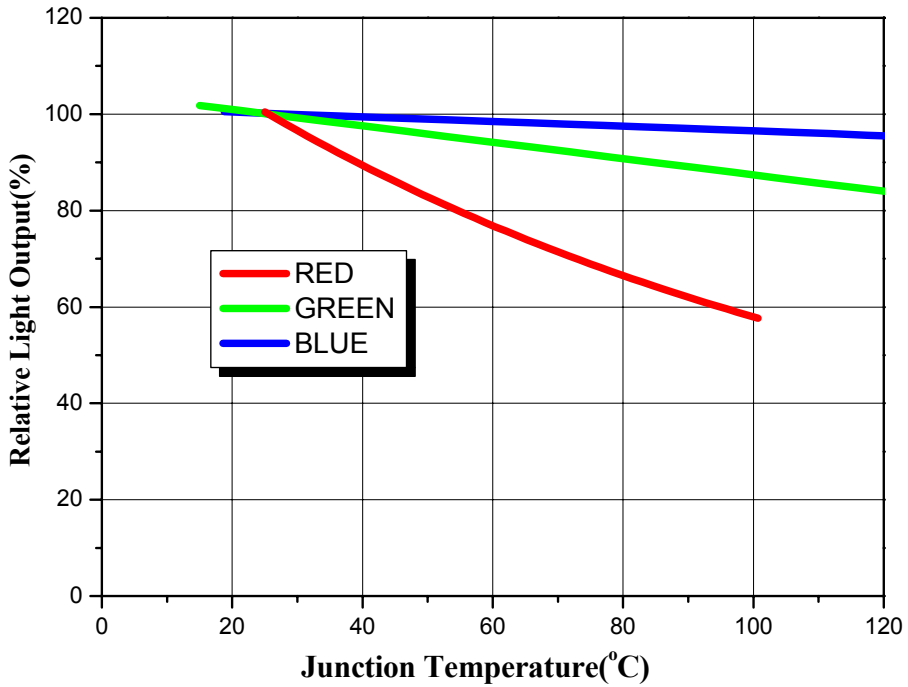

**18. Ambient Temperature vs Allowable Forward Current for 1 chip White,Blue,Green,Cyan**

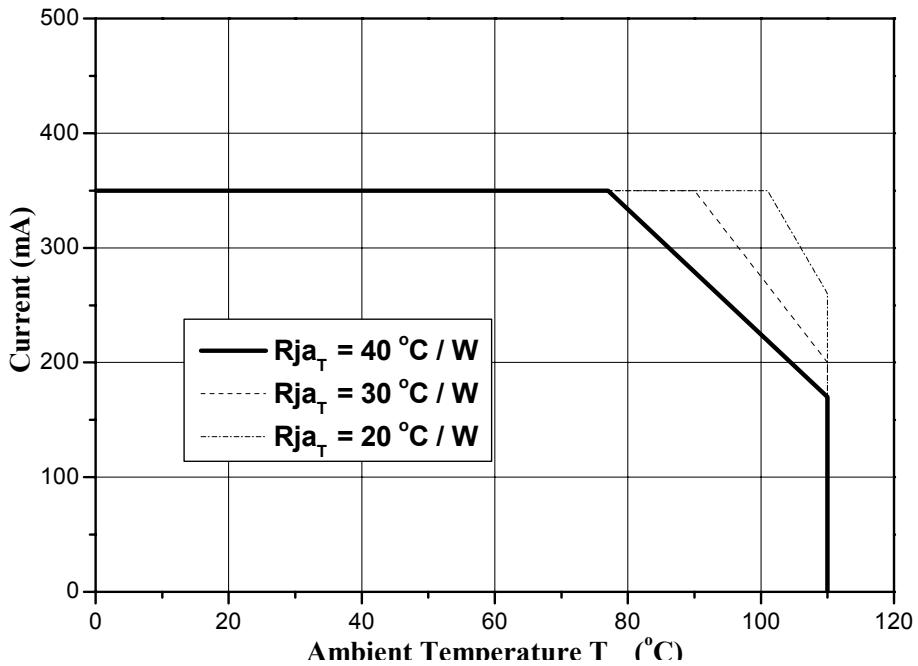

## 19. Ambient Temperature vs Allowable Forward Current for 1 chip Red, Amber

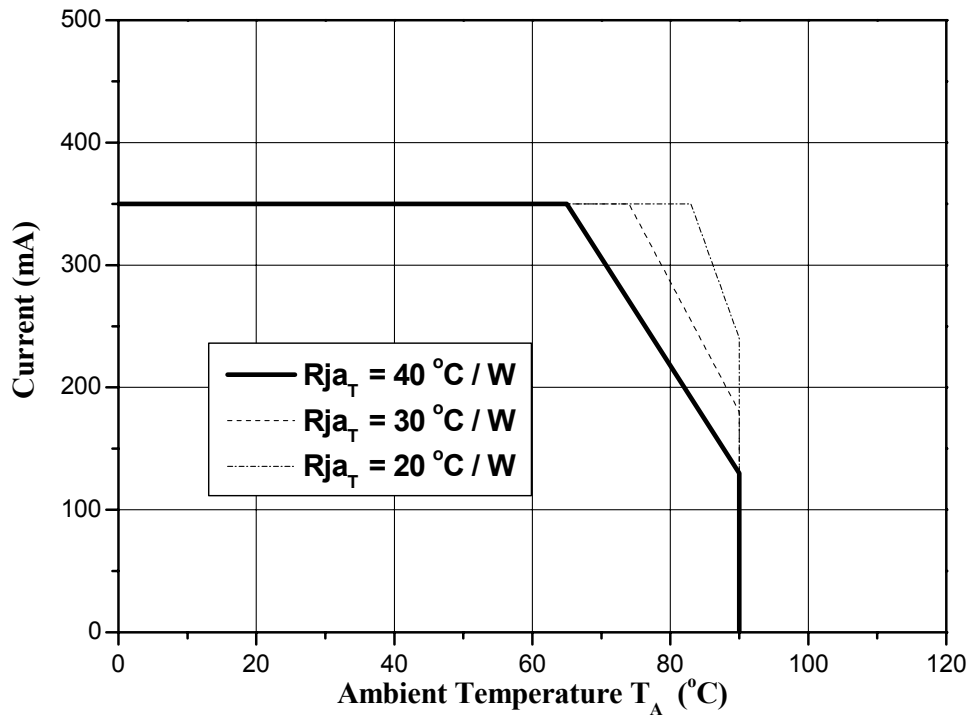

## 20. Reel Packaging

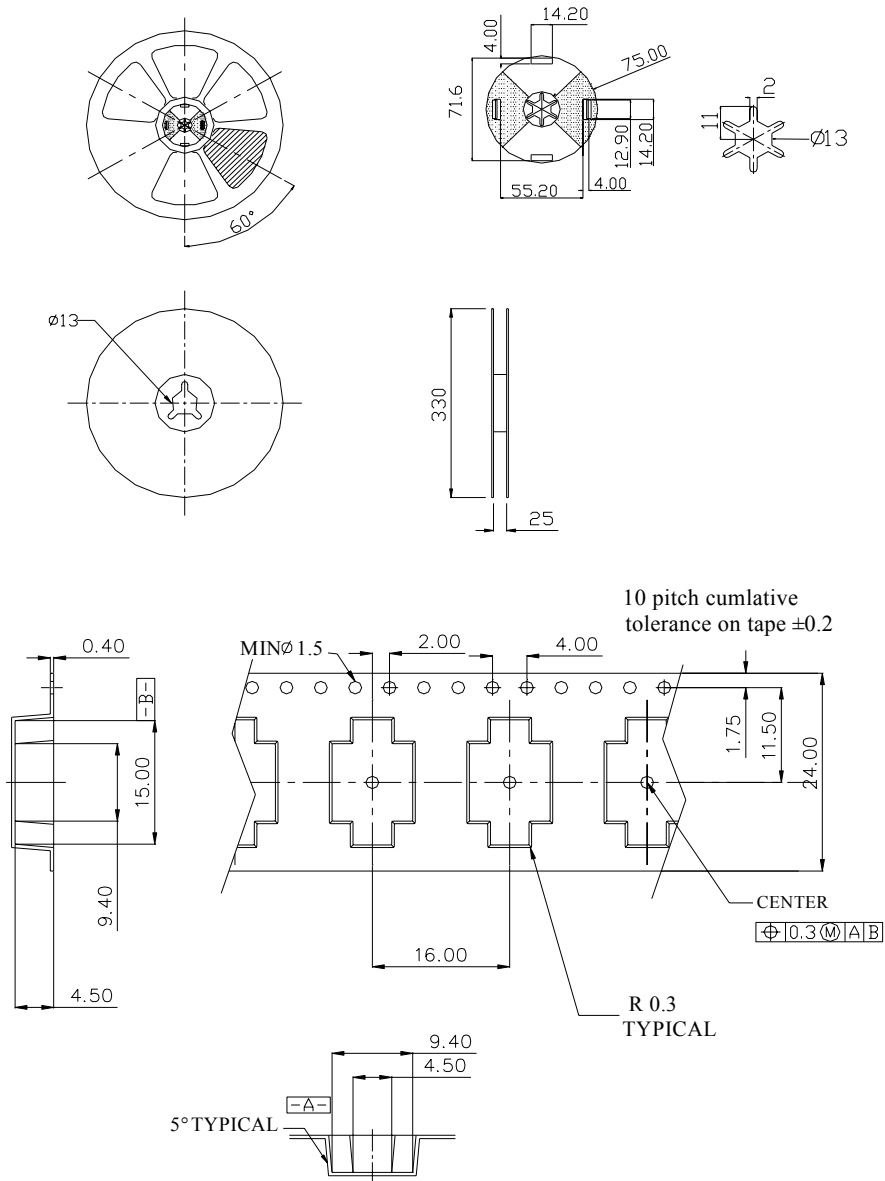

Note : 1. The number of loaded products in the reel is 250ea

2. All dimensions are in millimeters

3. Scale none

4. This drawing is reference only engineering



**SEOUL SEMICONDUCTOR CO., LTD.**  
 148-29, Kasan-Dong, Keumchun-Gu, Seoul, Korea  
 TEL : 82-2-3281-6269 FAX : 82-2-857-5430  
 Rev09 – 2005/09

## 21. Packaging structure

### Aluminum Vinyl Bag

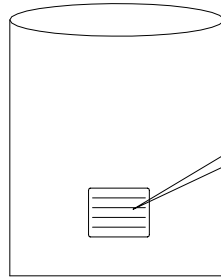

### Outer Box

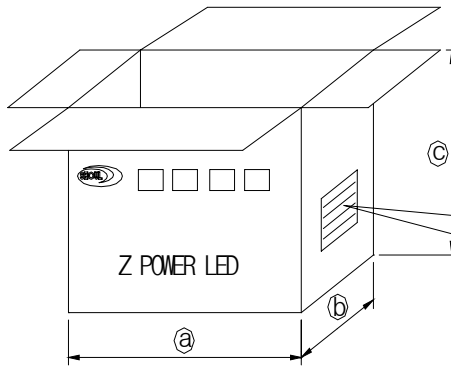

TYPE	SIZE(mm)		
	(a)	(b)	(c)
	340	350	200

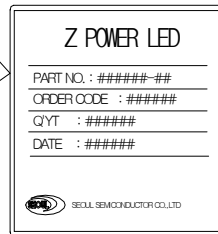

Note : 1. 5 reels are loaded in box

2. Scale none

3. This drawing is reference only engineering

4. For more information about binning and labeling, refer to the Application Note - 1



**SEOUL SEMICONDUCTOR CO., LTD.**  
 148-29, Kasan-Dong, Keumchun-Gu, Seoul, Korea  
 TEL : 82-2-3281-6269 FAX : 82-2-857-5430  
 Rev09 – 2005/09

## 22. Recommended soldering

### 1) Solder pad

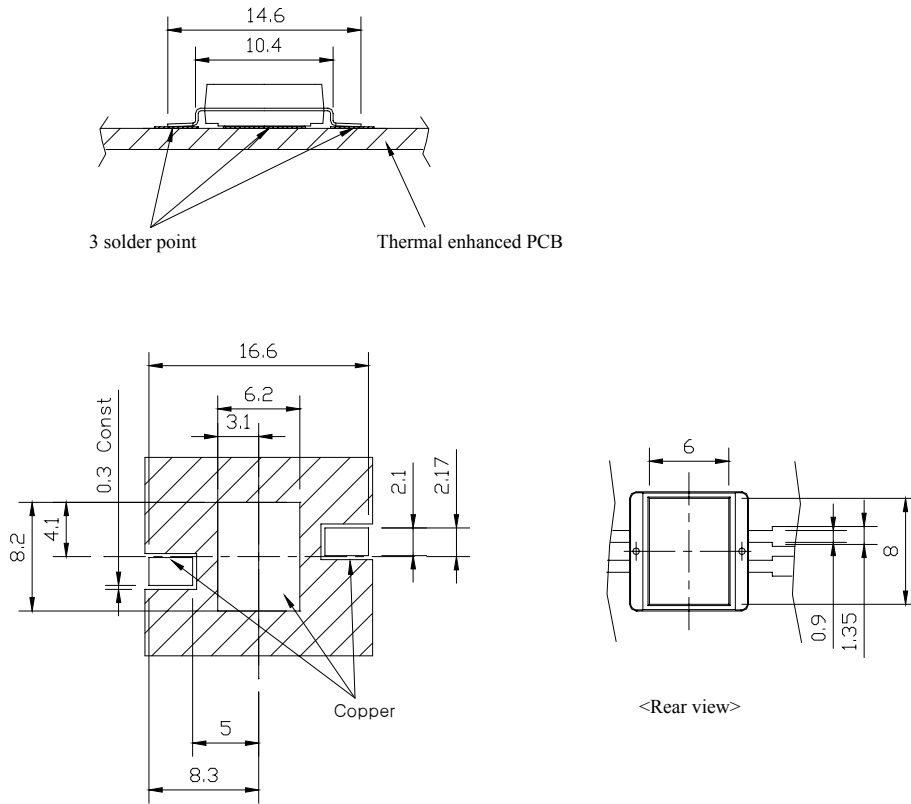

### 2) Solder paste pattern

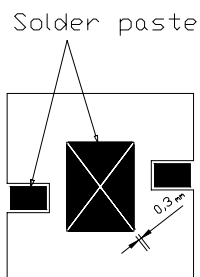

Note : 1. Paste thickness : 0.2mm





## 23. Soldering Profile (Ta=25°C ±5 / RH=35% ±5)

### (1) Reflow Soldering Conditions / Profile

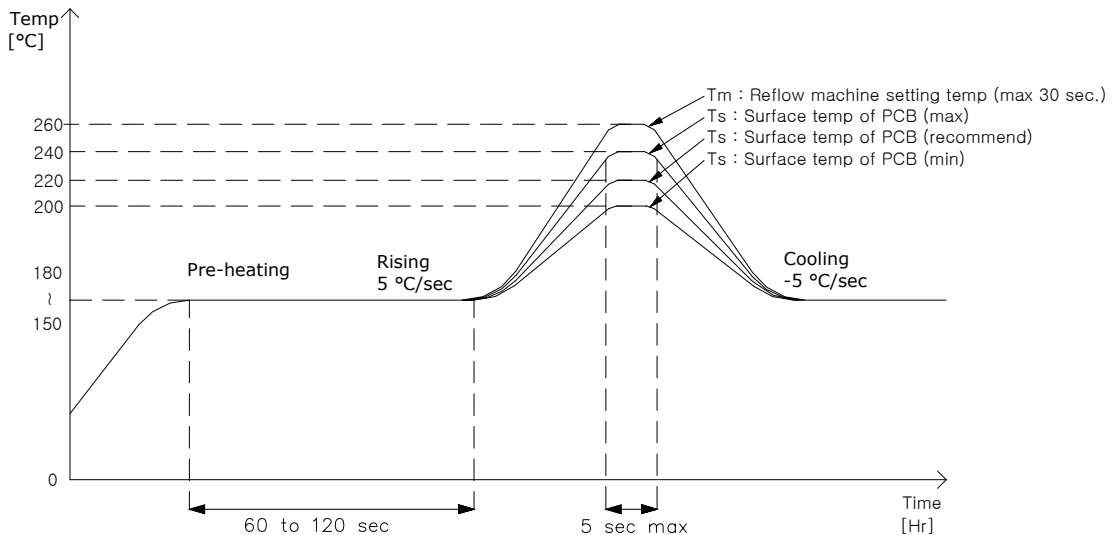

### (2) Hand Soldering conditions

- Lead : Not more than 3 seconds @MAX280°C
- Slug : Use a thermal-adhesives

#### \* Caution

1. Reflow soldering should not be done more than one time.
2. Repairing should not be done after the LEDs have been soldered. When repairing is unavoidable, suitable tools have to be used.
3. Die slug is to be soldered.
4. When soldering, do not put stress on the LEDs during heating.
5. After soldering, do not warp the circuit board.
6. Recommend to use a convection type reflow machine with 7 ~ 8 zones.



**SEOUL SEMICONDUCTOR CO., LTD.**

148-29, Kasan-Dong, Keumchun-Gu, Seoul, Korea

TEL : 82-2-3281-6269 FAX : 82-2-857-5430

Rev09 – 2005/09

## 24. Precaution for use

### (1) Storage

Avoid the absorption of moisture, we recommended to store Z Power LEDs in a dry box (or desiccator) with a desiccant . Otherwise, store them in the following environment:

Temperature : 5℃~30℃ Humidity : 50% max.

### (2) Precaution after opening packaging

However LED is correspond SMD, when LED be soldered dip, interfacial separation may affect the light transmission efficiency, causing the light intensity to drop.

Attention in followed.

a. Soldering should be done right after opening the package (within 24Hrs).

b. Keeping of a fraction

- Sealing

- Temperature : 5 ~ 40℃ Humidity : less than 30%

c. If the package has been opened more than 1week or the color of desiccant changes, components should be dried for 10-12hr at 60±5℃.

(3) Any mechanical force or any excess vibration shall not be applied to apply during cooling process to normal temp after soldering.

(4) Avoid quick cooling

(5) Components should not be mounted on warped direction of PCB.

(6) Anti radioactive ray design is not considered for the products listed here in.

(7) Gallium arsenide is used in some of the products listed in this publication. These products are dangerous if they are burned or smashed in the process of disposal. It is also dangerous to drink the liquid or inhale the gas generated by such products when chemically disposed.

(8) This device should not be used in any type of fluid such as water, oil, organic solvent and etc. When washing is required, IPA (Isopropyl Alcohol) should be used.

(9) When the LEDs are illuminating, operating current should be decided after considering the package maximum temperature.

(10) LEDs must be stored to maintain a clean atmosphere. If the LEDs are stored for 3 months or more after being shipped from SSC, a sealed container with a nitrogen atmosphere should be used for storage.

(11) The appearance and specifications of the product may be modified for improvement without notice.

(12) The package with lens can NOT be solder reflowed. It will damage the lens.

(13) Long time exposure of sunlight or occasional UV exposure will cause lens discoloration.

(14) Slug polarity is anode.



**SEOUL SEMICONDUCTOR CO., LTD.**

148-29, Kasan-Dong, Keumchun-Gu, Seoul, Korea

TEL : 82-2-3281-6269 FAX : 82-2-857-5430

Rev09 – 2005/09

## 25. Handling of silicone resin LEDs

**Z-Power LED is encapsulated by silicone resin for the highest flux efficiency.**

**Notes for handling of Silicone resin Z-Power LEDs**

- 1) Avoid touching silicone resin parts especially by sharp tools such as Pincette(Tweezers)**
- 2) Avoid leaving fingerprints on silicone resin parts.**
- 3) Dust sensitivity silicone resin need containers having cover for storage.**
- 4) When populating boards in SMT production, there are basically no restrictions regarding the form of the pick and place nozzle, except that mechanical pressure on the surface of the resin must be prevent.**
- 5) Please do not force over 3000 gf impact or pressure diagonally on the silicon lens.  
It will cause fatal damage of this product**
- 6) Please do not recommend to cover the silicone resin of the LEDs with other resin (epoxy, urethane, etc)**



**SEOUL SEMICONDUCTOR CO., LTD.**

148-29, Kasan-Dong, Keumchun-Gu, Seoul, Korea

TEL : 82-2-3281-6269 FAX : 82-2-857-5430

Rev09 – 2005/09

# Mouser Electronics

Authorized Distributor

Click to View Pricing, Inventory, Delivery & Lifecycle Information:

[Seoul Semiconductor:](#)

[N10190](#) [S10190](#) [W10190](#)